



PROJECT
14C

where creativity lives



ARTS 14C has partnered with GFP Real Estate to establish Project 14C, an incubator-style creative community for artists of all disciplines in the heart of Jersey City's Powerhouse Arts District.

We offer subsidized communal live/work loft spaces for 12-month as well as short term residencies, along with creative work spaces, a collaborative environment, mentorship and career development.

PROJECT 14C

Project 14C occupies the entire 4th, 5th and 6th floors of the landmark 150 Bay building, with its own private secure entrance.





Across the Hudson River from Lower Manhattan and New York City, Jersey City is one of America's most culturally diverse and vibrant cities, with more than 40 languages spoken.

Project 14C is in the Jersey City's Powerhouse Arts District, 10 minutes from Manhattan by PATH train.



The Project 14C vision

A program of ARTS 14C, Project 14C is an innovative co-living community designed for fine artists, filmmakers, writers, designers, performers - all the creative arts.

We believe that creativity flourishes in a vibrant, supportive and affordable community. Our mission is to provide a nurturing environment where diverse talents can come together to live, work, and inspire one another, while building the foundation for a lasting career in the arts with professional development & mentorship.

Project 14C offers modern, comfortable and subsidized studio living spaces and art facilities for our residents. The program period is one year, with a limited number of shorter residencies.

The Project 14C difference

More than 80% of residency programs are rural, offering artists the chance to focus on their work in a natural - often spectacular - setting, a respite from daily life.

Project 14C is inescapably urban and community focused.

We expect Project 14C residents to interact with one another, collaborate across disciplines and explore all of the creative opportunities in Jersey City and the New York City area. Our only requirement of our artists is 24 hours of volunteer service over the course of the year.

Although Project 14C's facilities are self contained, we regularly invite other members of the arts community - and the wider community - into our space. The 6th Edition of Art Fair 14C will occupy the 4th floor in May 2025, and there will be open studio events, as well as regular visits from artists, curators, arts administrators and other professionals who can help further the careers of our residents.

Facilities



- 48 furnished artist live/work loft spaces
- 20 artist work-only studios
- Community kitchens
- Private lobby & dedicated elevators
- Freight elevator/loading dock
- Laundry on each floor
- Large gym
- Fully ADA compliant
- Pet friendly
- Building has live-in super

Programs & amenities



- Mentorship and professional development
- Gallery 14C
- Recording studio
- Writers workshop
- Visual arts classroom
- Dance studio (future)
- Film production studio (future)

- Annual art fair
- Public open studio events
- Exhibitions with partner galleries
- Part-time jobs with 14C partners

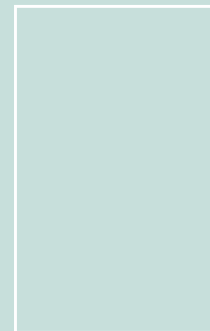
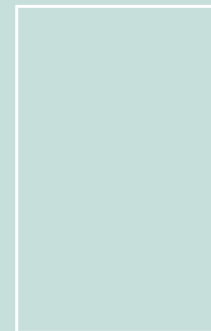

**Live/work loft studios range from 877
to 1504 sq ft with 12' ceiling height**

Each artist gets:
1 bed (twin or double)
2 desks
2 chests of drawers
2 armoires
each loft studio also includes:
two bathrooms
kitchenette
dining table/chairs

Average fee for shared space is \$1000 per month

Sample loft studio floor plan

Project 14C has 18 distinct studio configurations

**Smallest live/work loft studio -
for 1 or 2 artists**

1 artist - \$1,900/month
2 artists - \$950/month each

furnished, kitchenette,
2 bathrooms

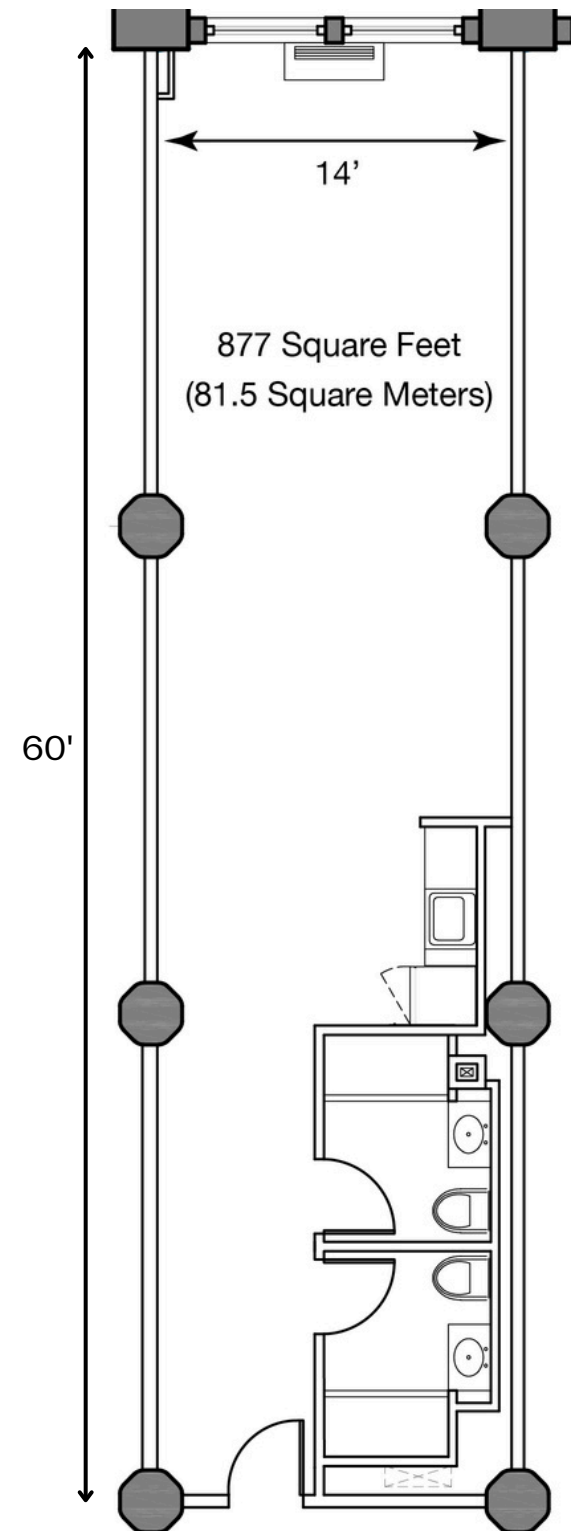
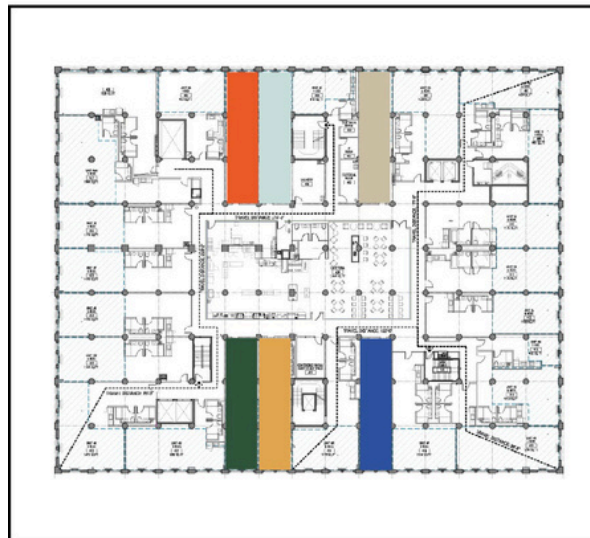

Live/work studio loft for up to 3 artists

1 artist - \$2,193/month
2 artists - \$1,096/month each
3 artists - \$731/month each

furnished, kitchenette,
2 bathrooms

Sample loft studio floor plan

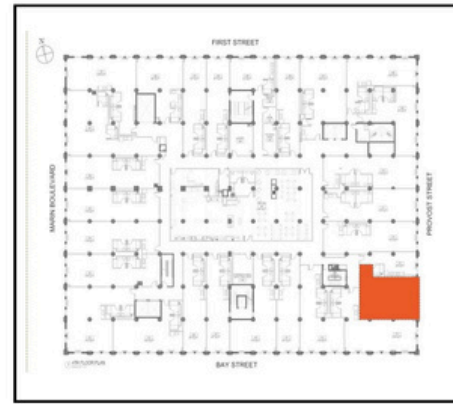

1012 Square Feet
(94 Square Meters)

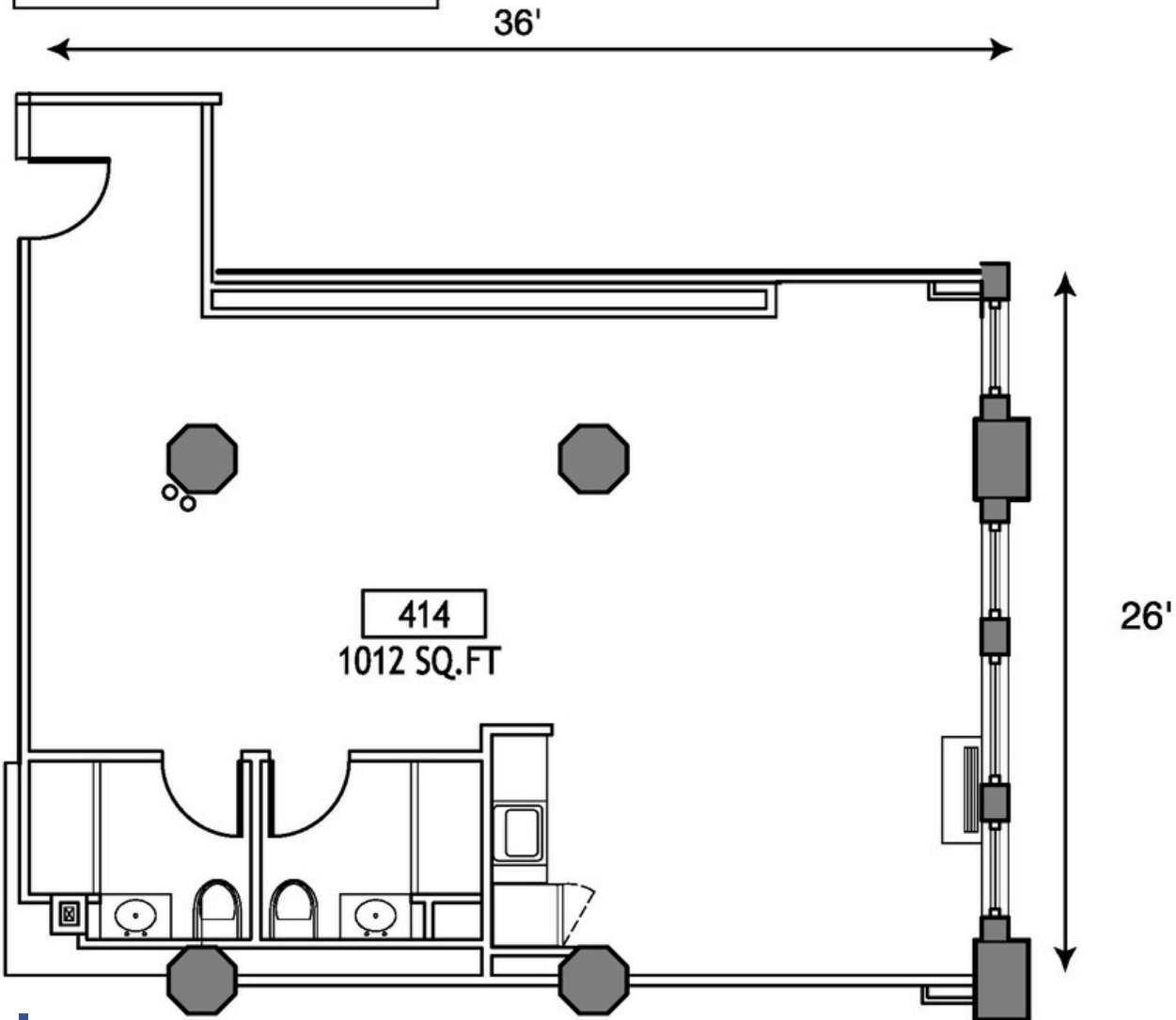

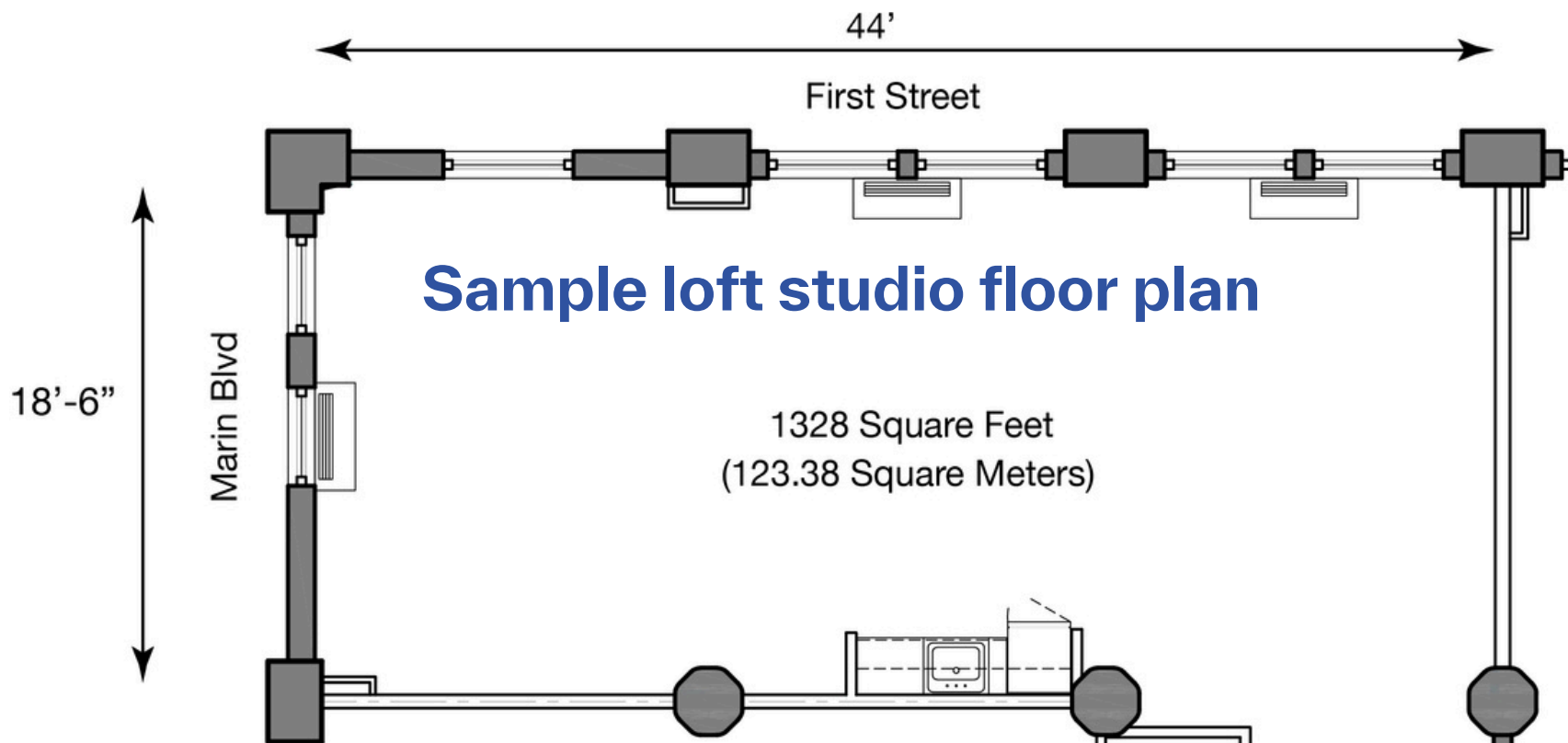

**Live/work loft floorplan
for up to 4 artists**

- 1 artist - \$2,877/month
- 2 artists - \$1,439/month each
- 3 artists - \$959/month each
- 4 artists - \$719/month each

furnished, kitchenette,
2 bathrooms

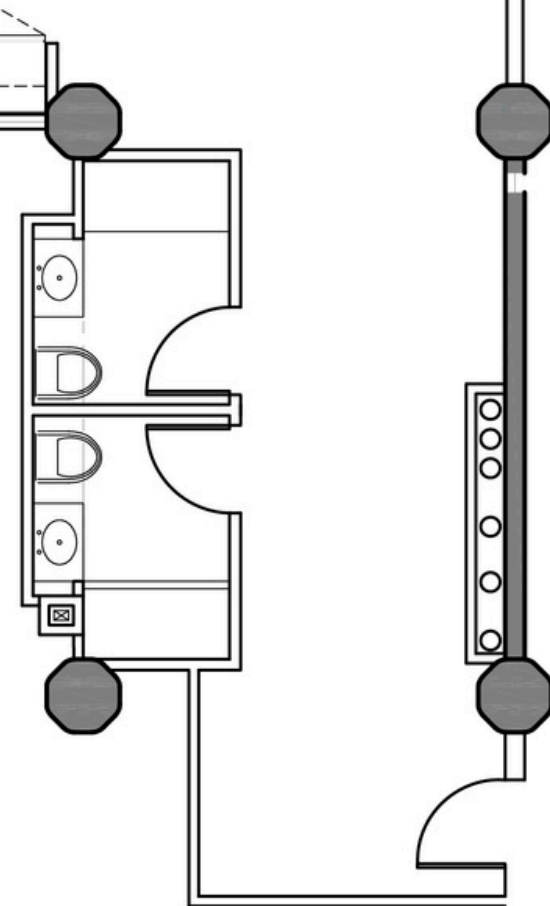
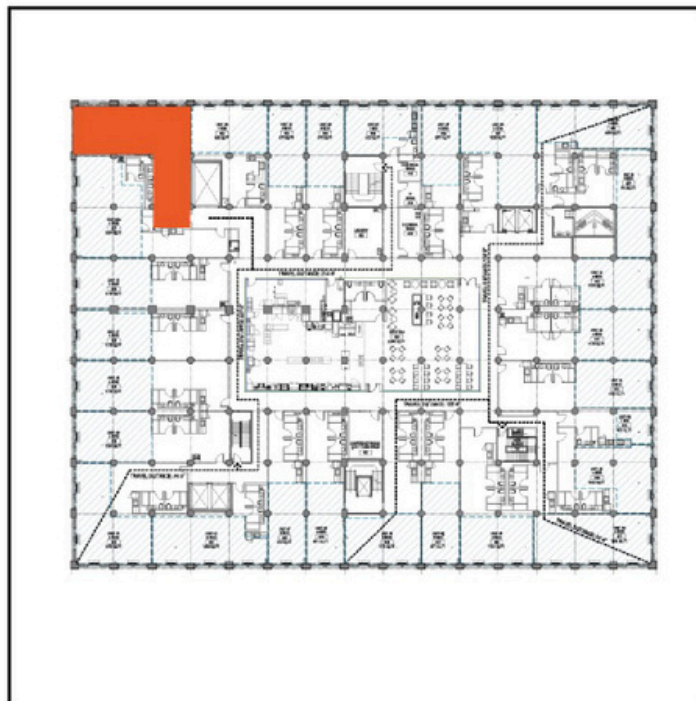

FAQs

[more FAQs at artfair14c.com/faq](https://artfair14c.com/faq)

Q. When does the program start?

A. Our official launch was February 2025, and we'll be adding approximately 10 artists each month on a rolling basis. Artists should apply no later than three months prior to their preferred start date - ie March 1 for a June 1 start.

Q. How many artists are in the program, and is it restricted to fine artists?

A. The space was built to house 432 student athletes, but we will likely be around 90 artists. All creative disciplines are welcome - visual arts, literary arts, performing arts, culinary arts, film, music, design, fashion, architecture, etc.

Q. Is there a requirement to complete a project or body of work by the end of the program period?

A. No - the purpose of the program is to be part of an inspiring creative community and to build the foundation for a lasting career in the arts. The only requirements are abiding by our Code of Conduct, and community volunteer time (two hours per month, or 24 hours over the course of a year).

Q. What if I already live in the area and just want a working studio?

A. We have large artist work-only studios on the 6th Floor that are available for rent for \$30 per sq ft per year. Artists renting these studios are able to participate in Project 14C programming, and are encouraged to engage with the community.

Live/work eligibility and costs

- Artists must be at least 21 years of age at the start of the program period.
- Artists must demonstrate talent and the desire to have a career in the arts.
- Artists of all creative disciplines will be considered for Project 14C, including visual arts, performing arts, literary arts, music, film, fashion, architecture, design and culinary arts.
- Because it is housed in an historic building, the program is not suited for artists who require open flame or toxic materials with fumes in their practice.
- Artists sharing a live/work space can expect to pay between \$800 and \$1,200 per month, with an average monthly cost of \$1000.
- Fees for artists living alone start at \$1900 per month.
- Program fees are all inclusive - no extra charges for utilities.
- Artists are accepted on a rolling basis, approximately 10 artists per month - artists should apply 3 months before desired start time (ie by March 1 for June 1)
- Application for Project 14C is open at arts14c.awardsplatform.com/



Project 14C studios can be live/work or work only

Work-only eligibility and costs

- Artists must be at least 21 years of age.
- Artists must demonstrate talent and the desire to have a career in the arts.
- Artists of all creative disciplines will be considered for Project 14C, including visual arts, performing arts, literary arts, music, film, fashion, architecture, and design.
- Because it is housed in an historic building, the program is not suited for artists who require open flame or toxic materials with fumes in their practice.
- Artists can rent studio spaces for a period of one year, which is then renewable.
- Studio fees range from \$2193/month (877 sq ft) to \$3760/month (1504 sq ft).
- Fees are all inclusive - no extra charges for utilities.
- Larger studios can be shared by more than one artist.
- Studio artists are able to - and encouraged to - participate in Project 14C programming.
- Application for Project 14C is open at arts14c.awardsplatform.com/

Partnerships

Project 14C partners with institutions and organizations to provide mentorship, professional development and opportunities for the resident artists of Project 14C.

Project 14C partners with the Canopy by Hilton hotel in Jersey City. Project 14C artists provide artwork for the public spaces at the Canopy, with Hilton paying a loan fee to each artist, providing professional photography and hosting promotional events.

Other organizations and institutions provide mentors for Project 14C artists and/or host special field trip visits.

Project 14C also provides work space on the 6th floor for arts organizations which provide programming for residents and desire an official presence in Jersey City.

Project 14C Advisory Board

Charles Aubin

Co-Director of Centre Pompidou Jersey City

Gary Clark

President Emeritus of the Vermont Studio Center and Managing Director of Prospect Street Writers House

Kristin DeAngelis

Director of Community Outreach at Mana Contemporary

Michael DeMarco

President Exchange Place Alliance, former CEO of Mack-Cali Realty

Johannah Hutchison

Executive Director of the International Sculpture Center

Jenna Laurenzo

feature film writer, director and actor

Irene Mei Zhi Shum

curator, architect and co-founder of Williamsburg Biannual

Lauren St John

award winning author of non-fiction and young adult fiction

PROJECT
14C

is a program of ARTS 14C

ARTS 14C

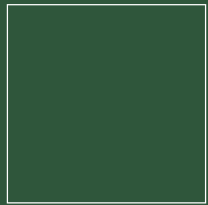

Project 14C

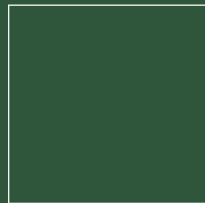
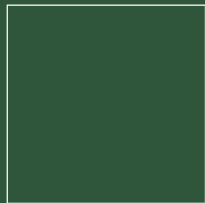
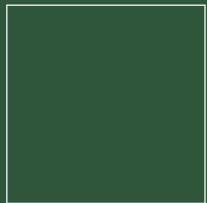
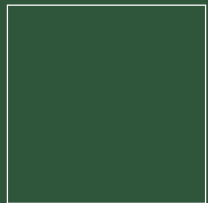
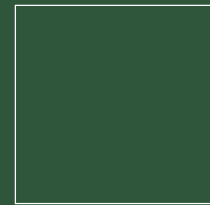
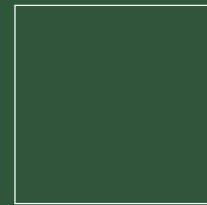
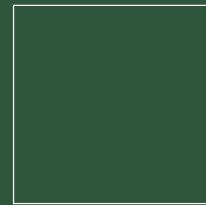
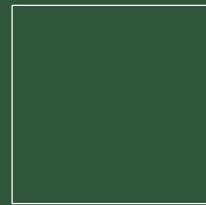

Art Fair 14C

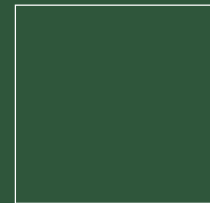

Jersey City Art & Studio Tour

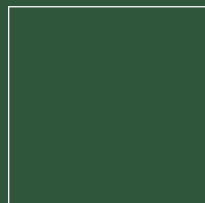
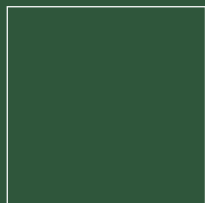
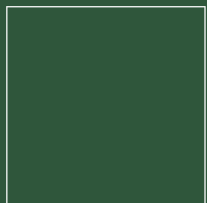
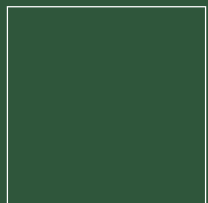
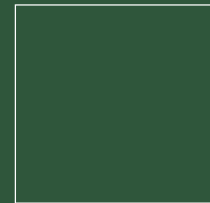
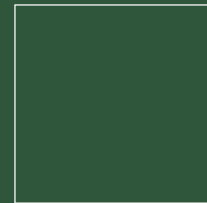

Gallery 14C

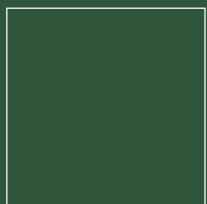
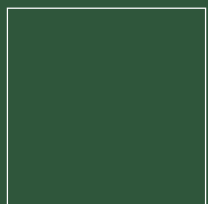

Art Crawl

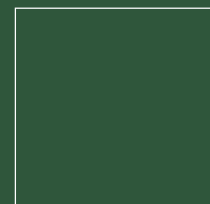
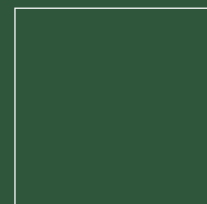
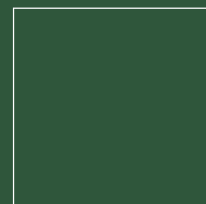
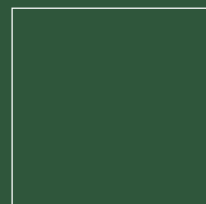

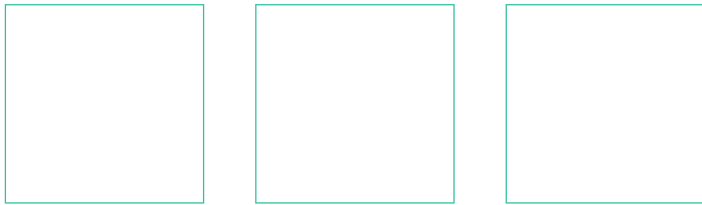
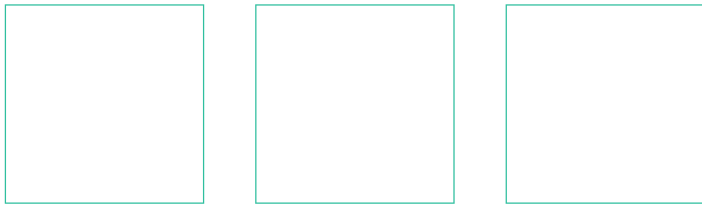
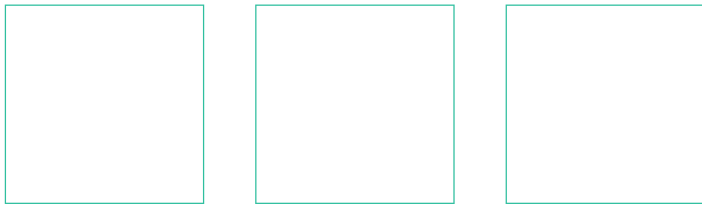
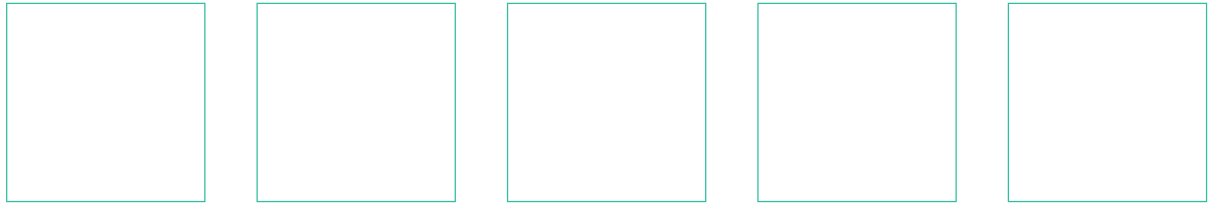
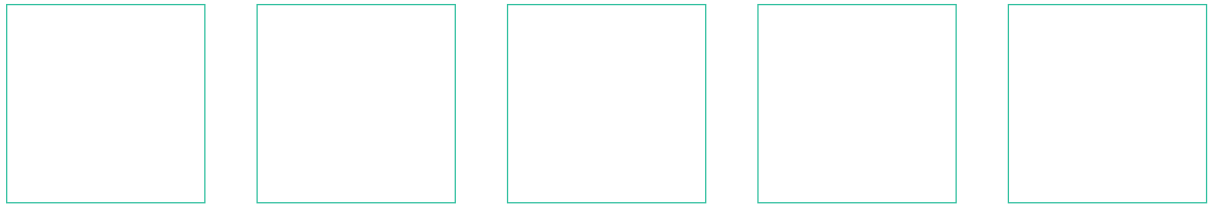

Our name is a wink to the old “what exit?” joke, and we take our Jersey-centric mission seriously. Although we serve artists and institutions from around the region, the country and the world, our strongest focus remains with the artists and art lovers of New Jersey.

Over our first six years, 14C programs have benefited more than 1000 artists and tens of thousands of art lovers.

ARTS 14C is focused on breaking down the barriers of the art world



Nonprofit Mission:

- Increase opportunities for artists
- Expand public access to art
- Strengthen careers in the arts
- Activate under-recognized art regions

“While other arts institutions in the state have retracted or tried their best to hold ground in a wider climate that isn’t too welcoming to arts innovation, 14C has grown explosively.”

-- Tris McCall in the Jersey City Times, May 3, 2024

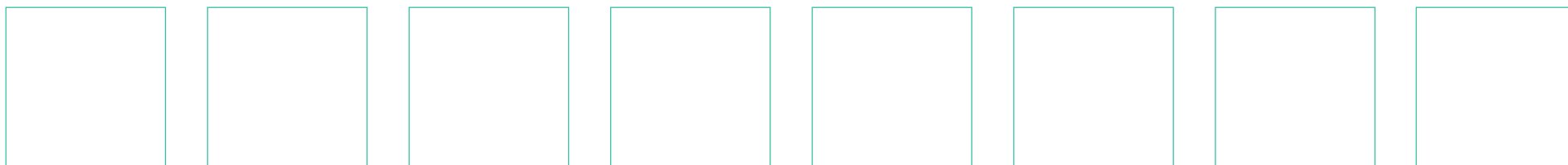
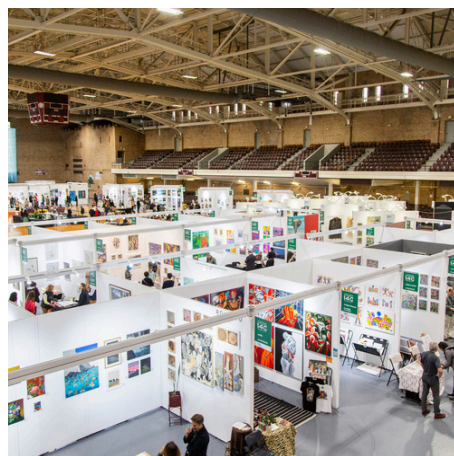



6th Edition

May 8-11, 2025

Powerhouse Arts District

To benefit Project 14C



JCAST

35TH ANNUAL JERSEY CITY ART & STUDIO TOUR

October 4-6, 2024



ARTS 14C took over operations of the annual Jersey City Art & Studio Tour from the City of Jersey City in 2023

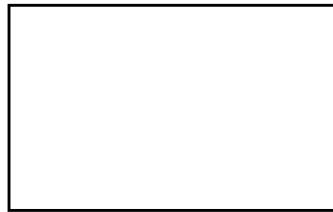

The Art Crawl is a walkable art and food tour of a single neighborhood, with galleries, open studios and food & drink partners

Art Crawl Downtown

Art Crawl Journal Square

Art Crawl Bergen-Lafayette

Art Crawl The Heights

★ Art Crawl HQs
Art150 - 157A 1st Street
 includes 4 galleries & 10+ studios
elevator studios - 135 Erie St
 includes 20+ studios

● Food & Beverage Partners

A Hamilton Inn - 708 Jersey Ave 15% discount for Art Crawl	G Downtown Yogurt - 126 Newark Ave Buy one, get one free
B Hamilton Park - 247 10th St 15% discount for Art Crawl	H Canopy JC Arts District - 159 Morgan St 20% discount at the Bar & Bistro
C Milk Sugar Love - 19 McWilliams Pl free chocolate chip cookie with purchase of 1 scoop size ice cream	I Bourke Street Bakery - 331 Marin Blvd 15% discount on all in-store purchases
D Chickie's - 236 Pavonia Ave 15% discount for Art Crawl	J Hudson Hall - 364 Marin Blvd 15% discount for Art Crawl
E Rumba Cubana - 235 Pavonia Ave 20% off all appetizers	K Alfalfa - 160 1st Street 15% discount on all in-store purchases
F Two Boots Pizza - 133 Newark Ave 10% off all in-store purchases	

Goldman Sachs



GALLERY
14C



The Gallery 14C program has provided exhibition opportunities for artists in New Jersey, New York , Arizona and Florida



ACCESS 14C

Access is one of the core values of 14C. We have worked with many artists with disabilities in our programs, and provide access tours to the public of our art fairs and exhibitions.

Our access tours include those for the visually impaired and low sensory tours for people who are on the autism spectrum or who have crowd anxiety.

14C has brought our low sensory tours to other organizations, including the Newark Museum.

ARTS 14C leadership

Robinson Holloway - Founder and CEO ARTS 14C



Holloway created Art Fair 14C as an initiative of the Jersey City Arts Council in 2018 while serving as its founding Chair of the Board of Directors.

She also serves as Chair of the Board of Directors of the global Association of Women Art Dealers, is a Director of the Hudson County Chamber of Commerce and co-chairs the Nonprofit Network. She had a 20-year career at ABC Sports.

Diana Burroughs - Executive Director Project 14C



Burroughs has a BA from the University of Wisconsin and earned an MA and PhD from Princeton University as a Fullbright recipient. Her nonprofit experience includes being co-founder and Executive Director of both PENCIL and TeachersCount.

In the art world, she has been president of Jason McCoy Gallery and director at Marlborough Gallery.

Sophie Couche - Artist Relations and Operations Director ARTS 14C



Couche is a program and artist manager with 10+ years of experience in the global arts and culture space. From international art shows in Paris and Sydney to cult-classic food institutions in New York, she has helped produce a variety of events by working with a diverse group of artists and patrons throughout her career.

ARTS 14C
157B 1st Street
Jersey City NJ 07302
info@arts14c.org
201-416-9067

arts14c.org

@arts14c **@project14c**

@artfair14c **@artcrawljc**

@gallery14c **@jc_artandstudiotour**

